

Technische Daten AGV2500

Rahmen	Stahl, pulverbeschichtet
Abtrieb	24V DC, 300W, 100 rpm
Gewicht	56 kg (inkl. batterie)
Gewicht Anhänger	2500 kg
Zugkraft (N)	2200N
Batterie	Eingebaut
Geschwindigkeit	Max. 2,0 km/h
Antriebsrädern	Vollgummi ø250x80 mm
Breite	540mm
Länge	1027mm
Höhe	529mm
Zusammengeklappt	Entfällt
Schalldruckpegel	68,5 dB
Zu verwenden von	-40 °C / 70 °C
Schutzart	Machine IP44

Abmessungen AGV2500

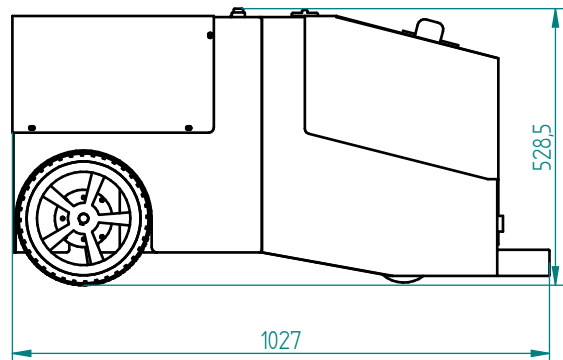
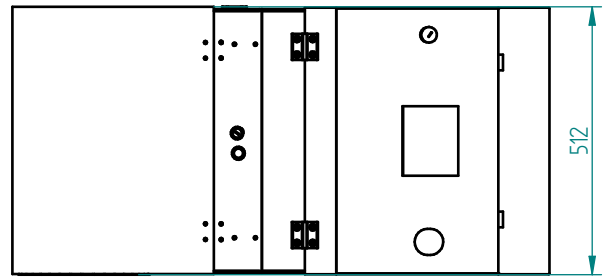

Zugkraft AGV2500 (in KG)

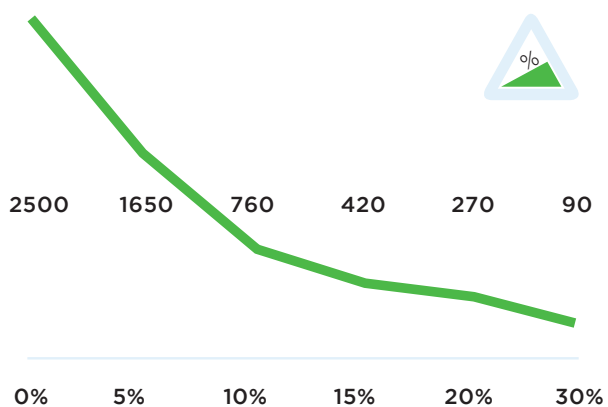

Standard AGV2500

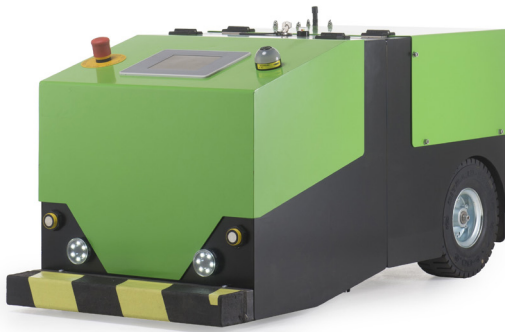

Standard parts AGV2500

Akku 12V-75A



*Eingebautes Ladegerät
24V-10A mit Rückkop-
plung*

Artikelnummer:
M2102

Eingebautes Lade- gerät 24V-10A Rück- koppl.



Artikelnummer:
M2134

Vollgummi An- triebsrad, Schwarz



*Vollgummi Antriebsrad,
schwarz*

Artikelnummer:
M0248

2 programmierbare Geschwindigkeiten



Standard parts AGV2500

Engine 600W 100RPM BREMSE 6911413X



Artikelnummer:
M2098

Batterieanzeige LBF318 LED



Artikelnummer:
M0123

Optionen AGV2500



**ZUSCHL Antriebsrad
Vollgummi nonm.
GRAU**

Bestellnummer
OPT0161



ZUSCHLAG Antriebsrad non-marking GELB

Bestellnummer
OPT0163



Hupe 103 dB

Bestellnummer
OPT0059



**Optische Sensoren
M30 400mm seite
AGV**

Bestellnummer
OPT0186



Stop Funktion Induktiv AGV

Bestellnummer
OPT0188



Kupplungs Staukasten

Bestellnummer
OPT0014



**Ein- / Ausschalter
Maschine**

Bestellnummer
OPT0016



Gegengewicht Rückseitig T1000

Bestellnummer
OPT0043



Schieb Stange

Bestellnummer
OPT0048



Stundenzähler komplette

Bestellnummer
OPT0056



Antistatik-Streifen

Bestellnummer
OPT0058



**RFID Tag Ø=50mm
d=3,3m,m**

Bestellnummer
OPT0095

Optionen AGV2500



Vorbereitung Elektrische Haken

Bestellnummer
OPT0143



Zündschloss Verschiedenschliessend

Bestellnummer
OPT0145



Zündschloss gleichschliessend

Bestellnummer
OPT0146



Kundenspezifische Programmierung

Bestellnummer
OPT0170



Einsteller Italsea

Bestellnummer
D0003

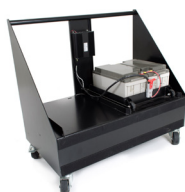

Ladestatione für Accu Pack

Bestellnummer
OPT0071



U-Rahmen für Abfallbehälter 1000/1100L

Bestellnummer
OPT0088



Klaphaken auf Schlepper, Diameter 16

Bestellnummer
H0128-D16



Klaphaken auf Schlepper, Diameter 20

Bestellnummer
H0128-D20



Klaphaken auf Schlepper, Diameter 25

Bestellnummer
H0128-D25



Klaphaken auf Schlepper, Diameter 32

Bestellnummer
H0128-D32



Klaphaken auf Schlepper, Diameter 25

Bestellnummer
H0128-D35

Optionen AGV2500

Grundhaken



Bestellnummer
H7070

Grundhaken Hoch

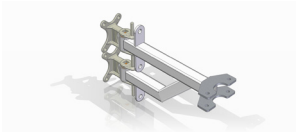

Bestellnummer
H7080

Haken geradestand Blockierung

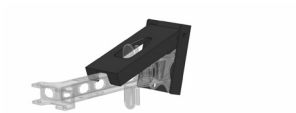

Bestellnummer
OPT0012

Hebemodul Elektrisch für Haken



Bestellnummer
OPT0050

Faltenden Haken für Blumenwagen



Bestellnummer
OPT0099

Unterstützung für auswechselbar Haken

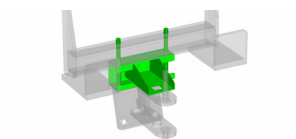

Bestellnummer
OPT0122

Verriegelung Für Ha- ken, elektrisch



Bestellnummer
OPT0129

Anzeige angeschlos- sene Last am Haken



Bestellnummer
OPT0187

Automatische Anhän- gerkupplung



Bestellnummer
OPT0200

Basismodule, Feder, Bolzen, Gegenplatte

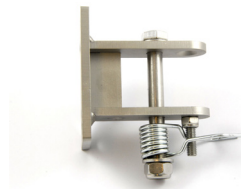

Bestellnummer
OPT0203



Willecke
Hebe- und Fördergeräte GmbH
 An der Becke 7 (Gewerbegebiet Ludwigstal)
 D-45527 Hattingen
 Tel./Fax.: +49 (0) 2324 / 39112 - 0 / -22
 info@willecke.de; www.willecke.de

