

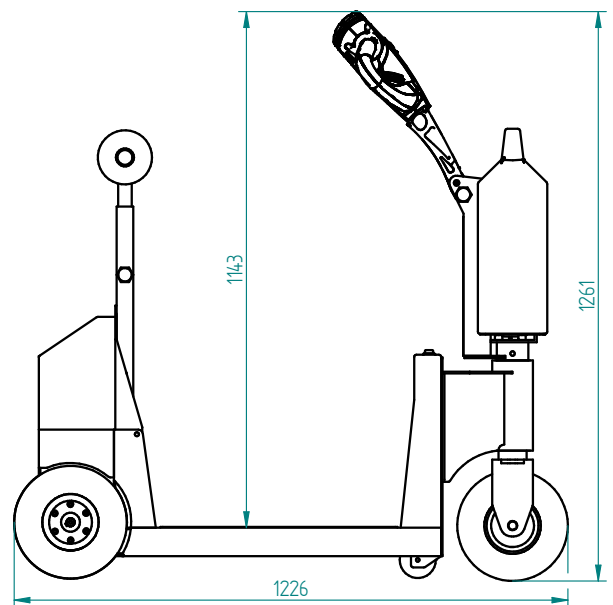

Technische Daten T1000-PLATFORM

Rahmen	Stahl, pulverbeschichtet
Abtrieb	24V DC, 420W, 140 rpm
Gewicht	70 kg
Gewicht Anhänger	1000 kg
Zugkraft (N)	800N
Batterie	Auswechselbar Batteriepack
Geschwindigkeit	Max. 6,6 km/h
Antriebsrädern	Vollgummi ø250x80 mm
Breite	450mm
Länge	1226mm
Deichsel Höhe	750-1261mm
Zusammengeklappt	900mm
Schalldruckpegel	63,8 dB
Zu verwenden von	-40 °C / 70 °C
Schutzart	Machine IP44

Abmessungen T1000-PLATFORM

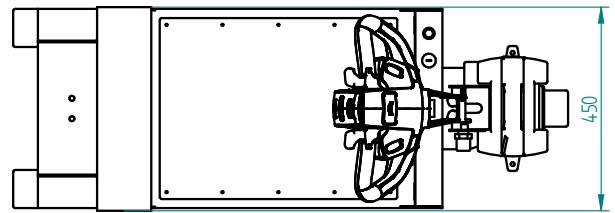

Zugkraft T1000-PLATFORM (in KG)

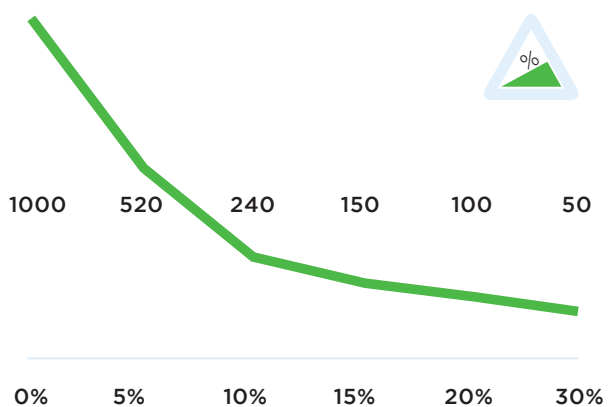

Standard T1000-PLATFORM



Standard parts T1000-PLATFORM

Ladegerät 24V 2A
inkl. Ladekabel



Artikelnummer:
OPT0009

Wartungsfrei AGM
Batterie 24V-20Ah,
6018



Artikelnummer:
OPT0110-RAL6018

Vollgummi An-
triebsrad, Schwarz



*Vollgummi Antriebsrad,
schwarz*

Artikelnummer:
M0248

Einstellbare Deichsel-
kopf



2 programmierbare
Geschwindigkeiten



Standard parts T1000-PLATFORM

Motor 420W 140RPM
BREMSE 6911439X



Artikelnummer:
M1034

Batterieanzeige
LBF318 LED



Artikelnummer:
M0123

Optionen T1000-PLATFORM



**Akku Lithium-LiFe-
PO4 25,6V-36Ah
GRUN**

Bestellnummer
OPT0106



**Akku Lithium stat-
tdessen Akku AGM
GRUN**

*Inklusive Ladegerät
OPT0023*

Bestellnummer
OPT0107



**Wartungsfrei AGM
Batterie 24V-20Ah,
6018**

Bestellnummer
OPT0110-RAL6018



**ZUSCHL Antrieb
Luftreifen Schaum 2b
SCH**

*ZUSCHLAG Antriebsrad
Luftreifen Schaumkern
2.0b SCHWARZ*

Bestellnummer
OPT0158



**ZUSCHL Luftreifen
Schaumkern 2b SCH-
WARZ**

Bestellnummer
OPT0160



**ZUSCHL Antriebsrad
Vollgummi nonm.
GRAU**

Bestellnummer
OPT0161



**ZUSCHLAG Rad Vol-
lgummi non-marking
GRAU**

Bestellnummer
OPT0162



**ZUSCHLAG An-
triebsrad non-mar-
king GELB**

Bestellnummer
OPT0163



**ZUSCHLAG Rad
non-marking GELB**

Bestellnummer
OPT0164



Hupe 90dB

Bestellnummer
OPT0045



Hupe

Bestellnummer
OPT0055



Hupe 103 dB

Bestellnummer
OPT0059

Optionen T1000-PLATFORM

Not-Aus Komplet



Bestellnummer
OPT0063

Blitzlicht gusseisen Deichselkopf



Bestellnummer
OPT0076

Stoßstange Rad



Bestellnummer
OPT0079

LED-Leuchten weiß inkl. Schalter

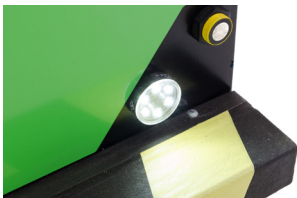

Bestellnummer
OPT0105

Blitzlicht im Front am Scooter



Bestellnummer
OPT0118

Blitzlampe



Bestellnummer
OPT0120

Kupplungs Staukas- ten



Bestellnummer
OPT0014

Ein- / Ausschalter Maschine



Bestellnummer
OPT0016

Fernbedienung



8-Kanal

Bestellnummer
OPT0024-3

Fernbedienung



6 Kanal

Bestellnummer
OPT0026-3

Stundenzähler kom- plette



Bestellnummer
OPT0056

Antistatik-Streifen



Bestellnummer
OPT0058

Optionen T1000-PLATFORM



Kodeschloss

Bestellnummer
OPT0068



Seilwinde T1000-PLATFORM Vorderseite

Bestellnummer
OPT0090



Seilwinde T1000-PLATFORM Hinter

Bestellnummer
OPT0092-1



LED-leuchten rot inkl. Schalter

Bestellnummer
OPT0093



Dokument halter

Bestellnummer
OPT0127



Vorbereitung Elektrische Haken

Bestellnummer
OPT0143



Zündschloss Ver- schiessend

Bestellnummer
OPT0145



Zündschloss gleichschliessend

Bestellnummer
OPT0146



Zündschloss unter grosser Deichselkopf

*Verschiessend
nur mit OPT0171*

Bestellnummer
OPT0147



Zündschloss unter grosser Deichselkopf

*Gleichschliessend. Nur
mit OPT0171*

Bestellnummer
OPT0148



Kundenspezifische Programmierung

Bestellnummer
OPT0170



Großere Deichsel

Mit 6 Schalterpositionen

Bestellnummer
OPT0171

Optionen T1000-PLATFORM



Einsteller Italsea

Bestellnummer
D0003



Ladestation für 1 AGM Batterie

Bestellnummer
OPT0015



Ladestation für 1 Lithium Batterie

Bestellnummer
OPT0023



Ladestation für 5 Batterien

Bestellnummer
OPT0039



U-Rahmen für Abfallbehälter 1000/1100L

Bestellnummer
OPT0088



Ladestation für 6 AGM Batterien

Bestellnummer
OPT0115



Verriegelung Ladestation mit 6 Einheiten

Bestellnummer
OPT0152



Klaphaken auf Schleppler, Diameter 16

Bestellnummer
H0128-D16



Klaphaken auf Schleppler, Diameter 20

Bestellnummer
H0128-D20



Klaphaken auf Schleppler, Diameter 25

Bestellnummer
H0128-D25



Klaphaken auf Schleppler, Diameter 32

Bestellnummer
H0128-D32



Klaphaken auf Schleppler, Diameter 25

Bestellnummer
H0128-D35

Optionen T1000-PLATFORM

Grundhaken



Bestellnummer
H7030

Grundhaken Handbetrieb



Bestellnummer
H7090

Haken geradestand Blockierung

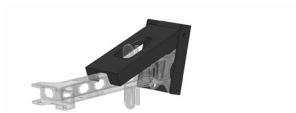

Bestellnummer
OPT0012

Hebemodul Elektrisch für Haken



Bestellnummer
OPT0050

Faltenden Haken für Blumenwagen



Bestellnummer
OPT0099

Unterstützung für auswechselbar Haken

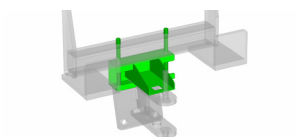

Bestellnummer
OPT0122

Verriegelung Für Ha- ken, elektrisch



Bestellnummer
OPT0129

Automatische Anhän- gerkupplung



Bestellnummer
OPT0200

Basismodule, Feder, Bolzen, Gegenplatte

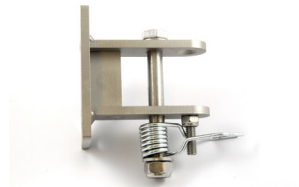

Bestellnummer
OPT0203



Willecke
Hebe- und Fördergeräte GmbH
An der Becke 7 (Gewerbegebiet Ludwigstal)
D-45527 Hattingen
Tel./Fax.: +49 (0) 2324 / 39112 - 0 / -22
info@willecke.de; www.willecke.de

