

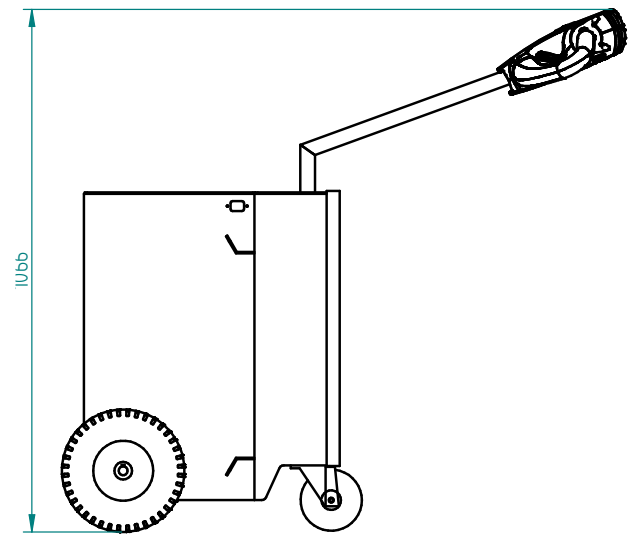

Technische Daten T2500-CLEAN ROOM

Rahmen	Edelstahl, Glasperlenstrahlen
Abtrieb	24V DC, 600W, 100 rpm
Gewicht	250 kg
Gewicht Anhänger	2500 kg
Zugkraft (N)	2200N
Batterie	Eingebaut, 24V, 75 Ah
Geschwindigkeit	Max. 4,7 km/h
Antriebsrädern	Nicht krebend Vollgummi ø250x80 mm
Breite	513mm
Länge	1147mm
Deichsel Höhe	1066mm
Zusammengeklappt	Entfällt
Schalldruckpegel	68,5 dB
Zu verwenden von	-40 °C / 70 °C
Schutzart	Machine IP44

Abmessungen T2500-CLEAN ROOM

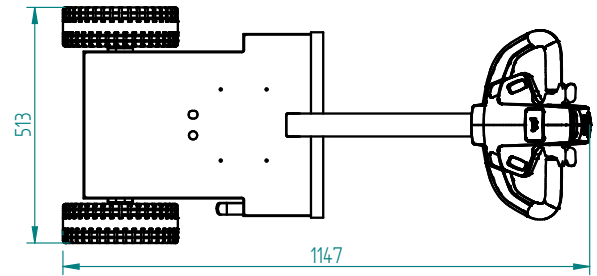

Zugkraft T2500-CLEAN ROOM (in KG)

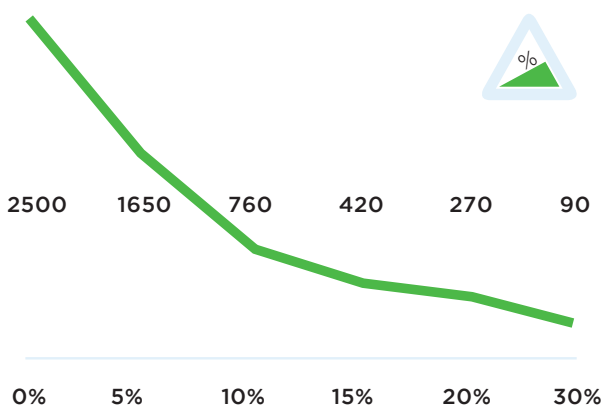

Standard T2500-CLEAN ROOM



Standard parts T2500-CLEAN ROOM

Akku 12V-75A



Artikelnummer:
M2102

**Eingebautes Lade-
gerät 24V-10A Rück-
koppl.**



*Eingebautes Ladegerät
24V-10A mit Rückkop-
plung*

Artikelnummer:
M2134

**Non-marking voll-
gummi Antriebsrad,
gelb**



Artikelnummer:
M0249

Sicherheitsschalte



Standard parts T2500-CLEAN ROOM

**Engine 600W
100RPM BREMSE
6911413X**



Artikelnummer:
M2098

**Batterieanzeige
LBF318 LED**



Artikelnummer:
M0123

**2 programmierbare
Geschwindigkeiten**



Optionen T2500-CLEAN ROOM



Hupe mit bedienung auf Bellybutton

Bestellnummer
OPT0049

Hupe 103 dB



Bestellnummer
OPT0059

Not-Aus Komplet



Bestellnummer
OPT0063

Blitzlampe



Bestellnummer
OPT0065

Bellybutton 2-Schritt Reset



Nach Bellybutton gebrauch aus/ein schaltung erforderlich

Bestellnummer
OPT0168

Dokumentenhalter mit Klammer



Bestellnummer
OPT0053

Stundenzähler komplette



Bestellnummer
OPT0056

Antistatik-Streifen



Bestellnummer
OPT0058

Kodeschloss



Bestellnummer
OPT0068

Vorbereitung Elektrische Haken



Bestellnummer
OPT0143

Zündschloss Verschiedenschliessend



Bestellnummer
OPT0145

Zündschloss gleichschliessend



Bestellnummer
OPT0146

Optionen T2500-CLEAN ROOM



Zündschloss unter grosser Deichselkop

Verschiedenschliessend nur mit OPT0171

Bestellnummer
OPT0147



Zündschloss unter grosser Deichselkop

Gleichschliessend. Nur mit OPT0171

Bestellnummer
OPT0148



Kundenspezifische Programmierung

Bestellnummer
OPT0170



Größere Deichsel

Mit 6 Schalterpositionen

Bestellnummer
OPT0171



Einsteller Italsea

Bestellnummer
D0003



U-Rahmen für Abfallbehälter 1000/1100L

Bestellnummer
OPT0088

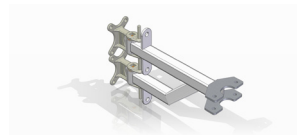

Grundhaken Hoch

Bestellnummer
H7080

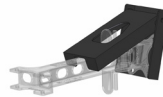

Haken geradestand Blockierung

Bestellnummer
OPT0012



Hubmodule für Haken Edelstahl

Bestellnummer
OPT0050-RVS

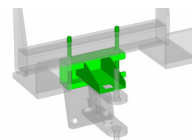

Unterstützung für auswechselbar Haken

Bestellnummer
OPT0122



Verriegelung für Haken, elektrisch

Bestellnummer
OPT0129

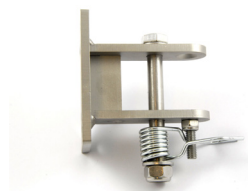

Basismodule, Feder, Bolzen, Gegenplatte

Bestellnummer
OPT0203



Willecke
Hebe- und Fördergeräte GmbH
An der Becke 7 (Gewerbegebiet Ludwigstal)
D-45527 Hattingen
Tel./Fax.: +49 (0) 2324 / 39112 - 0 / -22
info@willecke.de; www.willecke.de

